



CAMPFIRE 营火 *Light* 火

CATHOLIC HIGH SCHOOL SCOUT GROUP

MITA(P)NO. 245/06/2003

VOL. 44 DEC 2003



Highlights

55TH ANNIVERSARY CAMPFIRE

55TH ANNIVERSARY DINNER

MEMORIES OF PSA AND DCA HOLDERS



Catholic High School
Scout Group
55th Anniversary

Catholic High Scout Group
55th Anniversary Dinner





Note From The Co-editor

The path of knowledge runs ever so deep, even more so can be said about those who trudge the lanes of scouting. We, who are brave and stout of heart will carry ourselves proud and tall with nary a twinge of regret as we settle upon the delicate footholds of scouting. Scouting can be considered the greatest gift to mankind as it cultivates the very essence of the soul and mind of all who experience it, henceforth watch with pride as boys become men.

The year began with a bang, as we celebrated the 55th anniversary of our scout troop, we reveled in celebration at Mandarin Hotel and everyone from old boys to cadet scouts were invited to partake in the festivities. Old friendships were renewed and others forged, and there was no letting up as we immediately moved on to our 55th anniversary campfire 2 months later. The campfire was a huge success and soon we were in the competition spirit as the orienteering competition came along. As you can see, we have done much this year and it is through the persistence and perseverance of everyone that we have achieved so much.

Catholic High Scout group has come a long way indeed, from its humble beginnings in 1948 we have grown and capped various milestones in our history now, for the year 2003 we have taken on numerous projects and triumphed over everyone of them. We shall hope that we will remain strong and not be impeded by anything. As we step forth into the future we shall always herald the scout motto of

"BE PREPARED"





Editorial Committee:

Editor : Mr Andrew Chua
 Co-editors : Leon Michael Ryan
 Russell Lin
 Artist : Jamie Pang
 Compiler : Hoo Kuan Liang

CAMPFIRE LIGHT is published by
 the Catholic High School Scout Group,
 9 Bishan Street 22, Singapore 579767
 For inquiries regarding CAMPFIRE LIGHT reproduction
 of materials, please write to the above address.

Design, colour separation and printing by

PCL Printers (Pte) Ltd
 Pioneers & Leaders Centre
 4 Ubi View, Singapore 408557
 Tel: 6745 8733 Fax: 6745 8321

All Rights Reserved



CONTENTS

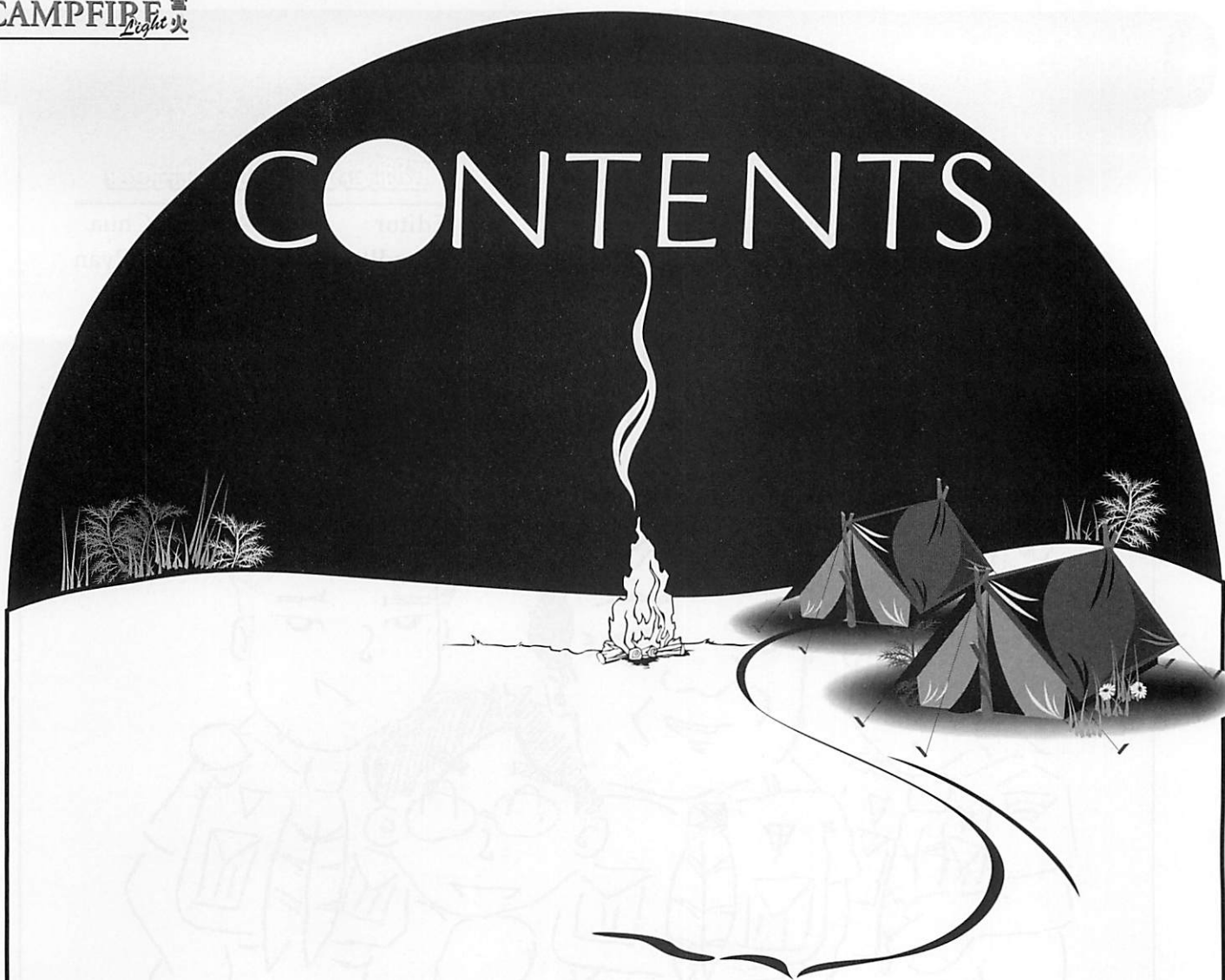

1. Orientation	3
2. 55th Anniversary Dinner	4 - 5
3. 55th Anniversary Campfire	6 - 8
4. District Field Day	9
5. June Camp	10 - 12
6. National Orienteering Competition	13
7. Inter-District Pioneering Competition	14
8. Girl Venture Investiture	15
9. Memoirs of PSA and DCA holders	16 - 17
10. Small Kindness Camporee President's Challenge	18
11. Master at Arms	19
12. Pioneering Knowledge	20 - 23
13. Scouting: Contemporary or Original?	24



12pm, was the time the secondary ones had to fall in as before that they were in the BURST program. The seniors however were in school long before 12 and were waiting for us with our test work.

After a short session of test work, the sec ones joined us and we began with the activities for the day, basically they were all fun filled games for us to enjoy!

Before the games, the sec ones were assigned to the various patrols and each patrol had at least one sec one. Following this was Patrol In Corner, where we could get to know each other better. The sec ones were also briefed on what to expect in scouts and the expectations of themselves.

At about 1 in the afternoon, we finally started with the games. First up was a game, which required skill and strategy in order to win. This game's objective was to finish (as far as possible) an apple, which was floating in a pail of water, without using one's hands. It sounded easy, but in reality it was horribly difficult. Only Eagle managed to successfully bite down that apple.

Following this was a tug of war, in which strength was the key to winning. Strategy also played a pivotal role. The patrol that emerged victorious was wolf patrol. Then the finest that would be strong and big sized were selected to challenge the sec 4 ventures. It was a tough battle, but eventually the sec 4's were defeated soundly. Everyone was dumbfounded upon knowing the results including me!

The last event of the day was an inter-patrol soccer tournament where patrols were merged together to form four patrols. The competition was very intense and everyone was playing hard but in the end, the two combine patrols which were to face each other in the finals were tiger and shark against wolf and cobra. The finals were a pitched and very tight ball game. It dragged on into a penalty shootout where wolf and cobra managed to sneak a victory over tiger and shark. It was a very fun match both to partake in as well as spectate. Everyone loved it tremendously.

After the games, we cleared up the area and were dismissed. We left, but taking home with us this wonderful and memorable experience...

*Al-Gene Tan
Tiger*

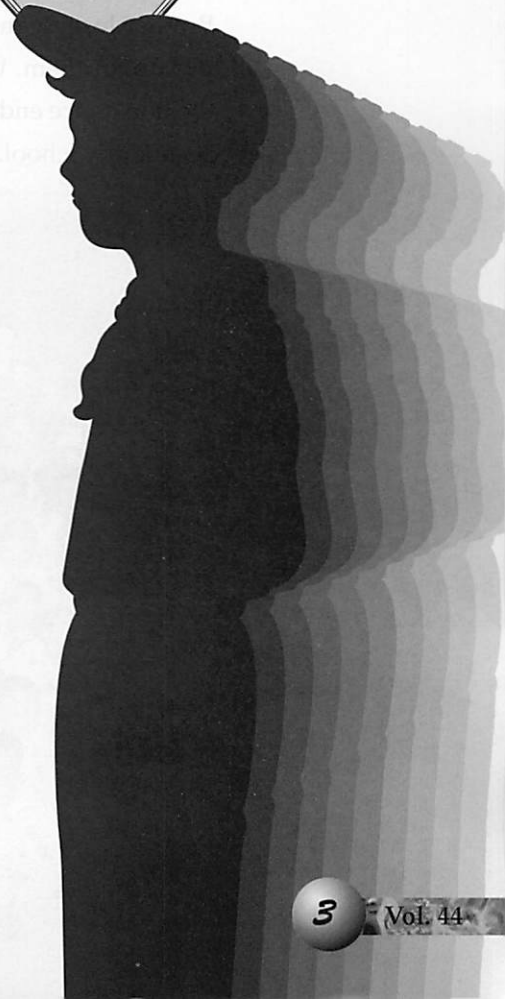

5 | 5 th Ann

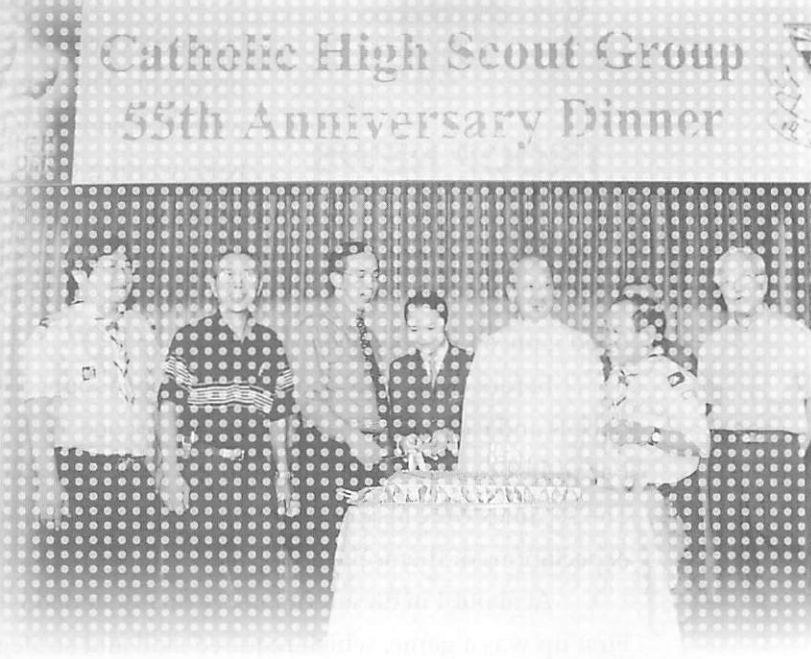
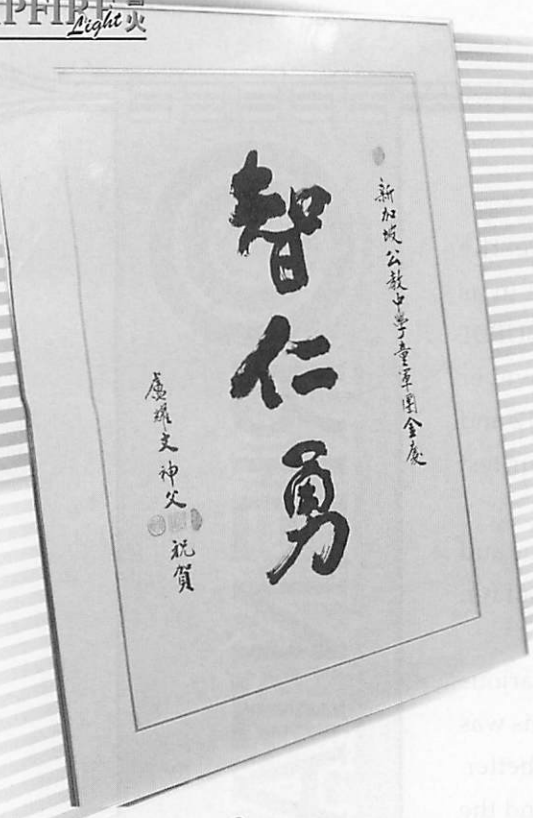

On the 25th January which was a Saturday, we celebrated our 55th anniversary at the Mandrian Hotel. Taking a bus there, we arrived at about 6.00 p.m.

Upon arrival, we sat down in patrols in the hall as the ventures tested the microphones and sound system. Finally at about 7.00 p.m. everything was ready and the cadet scouts arrived too. We went to the tables where every patrol was supposed to sit and wait quietly for the VIPs and guests to arrive.

Soon guests started streaming in and tables were slowly filled up. Then the VIPs arrived, Brother Joseph and our principal Mr Lee Hak Boon. A lion dance performance was specially put up for them. We all looked in amazement as the lion's jumped and danced around. After the lion dance ended we gave a huge round of applause for the lion dance troupe from Pioneer Secondary School.



Anniversary Dinner



Following up next was the I-movie made by our very own scout Teo Zi Yan for this year's anniversary. It was a very captivating movie as the movie showed our troop in the past and how we have grown throughout the years. The touching music that came with the movie further enhanced its allure.

After the I-movie was a speech made by Brother Joseph. His speech was about his past during the days when he was with Catholic High Scout Group, the interesting things he went through and how it has changed his life for the better. His speech both tickled our funny bones and touched us in many ways as he used humor to lighten up the mood and bring to life the emotions that he has carried for the past years.

Right after this the principal, Mr Lee Hak Boon gave his account of how he has fared working with the scout troop. It was short but very meaningful as he pledged his full support for the scout troop. Finally Mr Andrew Chua our GSL surprised everyone with his speech which was delivered in Mandarin.

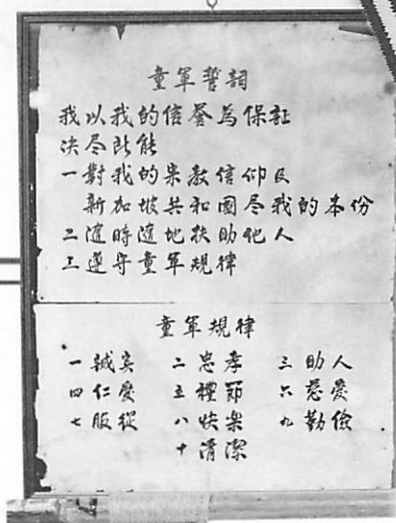

While all these great speeches were delivered the dinner proceeded as usual and everyone enjoyed their meal. During the meal we had a karate demo by members of the Seitoku Kan Goju-Ryu.

Soon after the dinner we were rushed into photo taking which will definitely leave us with all the right memories of an enchanting dinner spent celebrating the 55th anniversary of the troop. Following this we sang the school song and then with a great sense of reluctance we parted company as we were dismissed.

This was indeed a wonderful magical experience and it will stay vivid within my mind forever as a shining example to the generations that come after us.

Aaron Ng
Shark Patrol





5 | 5 th

Day 1

The day dawned bright and clear as we gathered at Kebun Baru. It was our troop's 55th anniversary campfire and this year, we were holding it at Kebun Baru, as our secondary school field was unavailable due to the ongoing construction. Half of our troop was allocated at Catholic High School to carry tables, benches and our equipments over onto a lorry that was bound for Kebun Baru. The other half was to assist in the equally important preparations at Kebun Baru. When we reached there, our tower had been already completed at the base and many ventures could be seen on the tower itself, tying their way up. The sec 3s were immediately called off to assist in constructing the tower while some sec 3s and sec 2s were allocated to tie the backdrop. Meanwhile, the other sec 2s and sec 1s practiced campfire songs.

The sun soon came up and it was blazing hot, by noon, all of us were perspiring heavily. At about 12:30pm, the lorry arrived and all the sec 2s and sec 1s went over to unload all the tables and benches. After we finished unloading the lorry, it returned back to school as there was still more benches and tables to be ferried over. We then had our lunch and after lunch, we went back to our respective jobs.

Soon, the lorry returned with another load of tables and chairs, and we put down whatever we are doing and went to assist in unloading the lorry. After making several trips to and fro, the lorry finally finished ferrying all the equipments and the troop. We went on with our respective work and soon, it was nightfall, we then erected our backdrop to see whether it would be stable. After raising it many times, we made several improvements to make it more stable.

By then, the tower was already soaring towards the sky but still we had yet to complete it. We then had our dinner and after dinner, it was back to the grind again. We worked until late in the night and finally at about 11pm, not before being sent off to wash up, we were sent to sleep. Too exhausted to be picky, many scouts simply sprawled onto the hall floor, and slept.

Day 2

Upon waking up, we went to wash up and then had a short morning PT. After morning PT, we had our breakfast and then we resumed our duties. We began to lay out the benches to form a semicircle facing the stage. After that, tables were laid to form the stage and then tied the table legs

Anniversary Campfire

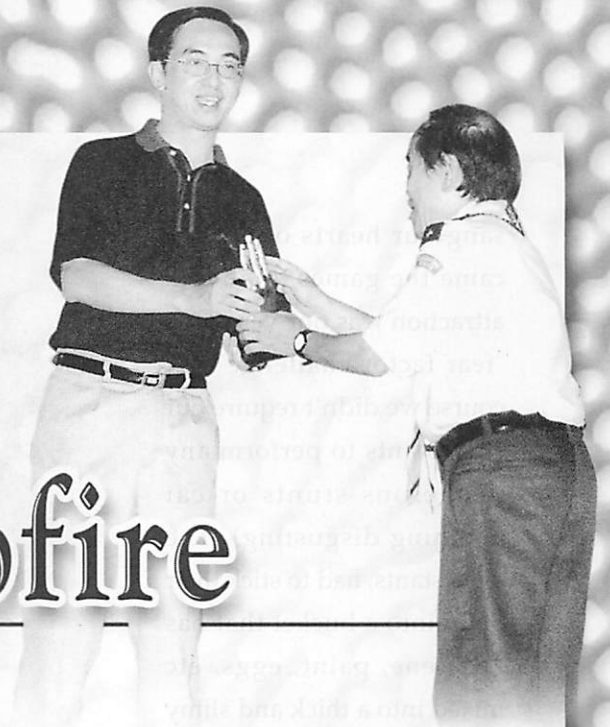

together to secure it. By lunchtime, our backdrop was already up and the tower was nearing its completion. Our fire pit was then set up, and we were then briefed about the night's campfire and the cadet scouts arrived shortly after. We then had a rehearsal for that night's campfire, where we practiced all our songs over and over again to the satisfaction of the leaders. Soon, we changed into our full uniform and waited for the arrival of all our guests.

Brother scouts and sisters guides began arriving and they all marveled at our magnificent tower. They took their respective seats but disappointingly, Holy Innocents did not turn up. Soon, the long awaited campfire started, with the night's MCs Russell and Aaron inviting Mr. Chua,

our GSL to declare the campfire open followed by the song "Campfire's burning". We then participated in various campfire songs and all of us



sang our hearts out. Then came the games, the main attraction was our very own "fear factor challenge" (Of course we didn't require our contestants to perform any dangerous stunts or eat anything disgusting). The contestants, had to stick their hand into a bucket that has kerosene, paint, eggs, etc mixed into a thick and slimy concoction to retrieve a card. The guides were all very sporting and each of them bravely dug into the foul concoction to retrieve their cards. After the games, we viewed the spectacular performances brought to us by many schools who participated enthusiastically. All good things have to come to an end and soon, it was time to declare the campfire closed.

The guests were then sent off for refreshments at the canteen and we were given some time to mingle around. Soon, all our guests left and we were left to clean up the place. Firstly, we took down the backdrop and untied it; the others then went to the tower and started to untie it too. Some were stationed at the wood rack to keep the wood that was to be kept. Others helped to stack the benches into stacks and untie all the twine that was holding



the tables. It was indeed a busy night and we worked quickly. Upon reaching 2 am, we all became sleepy and strove not to fall asleep. The tower was soon down and we all helped to untie it. The benches and tables were then counted and accounted for. We worked until 4 am, and by then, all of us were striving to keep our drooping eyelids open and we were relieved that we would finally get a bit of sleep. We trudged towards the hall and within moments, we were all sound asleep.

Day 3

We woke up at 7 am, luckily for us, there was no morning PT. We then promptly packed all our things on the lorry and headed back for school. We were then debriefed and we ended with a ... BERSURAI! While the campfire had ended, many of the experiences certainly live on in our memory. For many secondary ones, this was the first time they had their own campfire. For them, the sight of the magnificent tower and the antics of the two MC stirred feelings of great passion for the scout troop. For the rest of us, it was certainly a time of bonding both inside the troop, as well as our other brother scouts and sister guides.

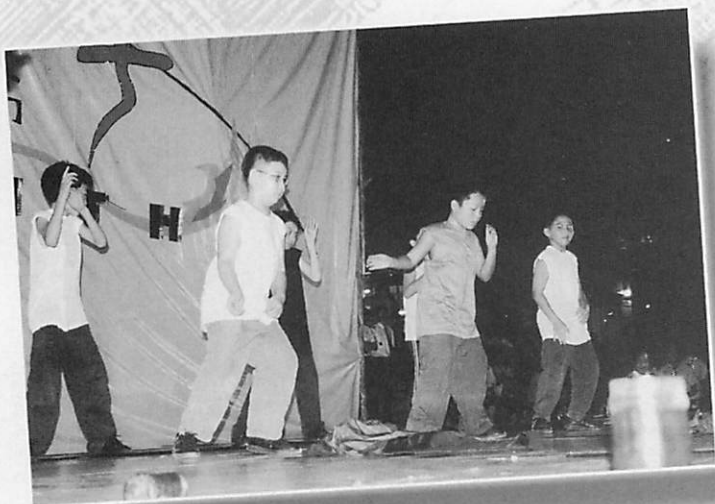

*Ng Guang Wu
Wolf Patrol*



Ang Mo Kio District Scout Field Day



Today, our meeting was held at the Kebun Bahru premises. We all had to come down at 7.30.a.m. to get ourselves mentally prepared for the competition later that day. Everyone in the troop felt the tension, as each of us has to participate in the different District Field Day categories. There were 3-2-1 flagpole, Backswood cooking, Chariot Race, Sour Grapes, War games, Orienteering, Captain's ball and soccer.

After a short journey, we finally reached the "coliseum": Zhong Hua Secondary School. Everyone was filled with anticipation, hoping to bring glory to both the troop and the school. Though some people were brimming with confidence, some waited anxiously at the stands while others paced around like cats to soothe their nerves. Our troop spirit was shown when we helped others by comforting them.

The competition finally kicked off with the 3-2-1 flagpole, where the participants had to build a flagpole out of 6 pieces of wood. They had to test their ability to tie quickly and to break a flag in the shortest possible time. Due to the amount of practice, the team had, they won it in a breeze. However, we had quite a tough competition against Zhong Hua Secondary. We only breathed a sign of relieve when it was all over.

Next, we had the Sour Grapes race that involves a team of about 5 people. As team members climb up the pole, the rest of them had to support the base, preventing the person from falling. Each team member was brimming with confidence even if the competitors from the other schools were too filled with a burning desire to win. Our training proved successful as we successfully clinched the gold medal once again.

We met our downfall at the chariot race that I participated in. Everyone in the team felt very anxious and touchy as it was not as we had expected. The rules had changed during our final preparations. The race started 5min after we had finished our preparations. We finished tying our chariot within a mere less than 1 min, However, I bumped into the Mayflower's Scout Leader who was taking pictures in the middle of the track. This caused us to lose our head start, we could have gotten 2nd place but the judges said we were disqualified for the race and had to start all over again. After the entire hassle, we still managed

to clinched 3rd. Due to that incident, I was very angry and disappointed with the results as it was partially my fault that we got such a lousy grade.

The troop did not take it so hard and went on with the other competitions with a burning spirit to win. In the end we managed to clinch an overall gold, winning the top prize, bringing glory to the troop. It was comforting to know that despite my small error, the troop was still supportive and comforting, even in its victory. And perhaps it is such friendship and camaraderie that is of most importance - more so that any prize that we may win.

*Yun Le
Shark Patrol*

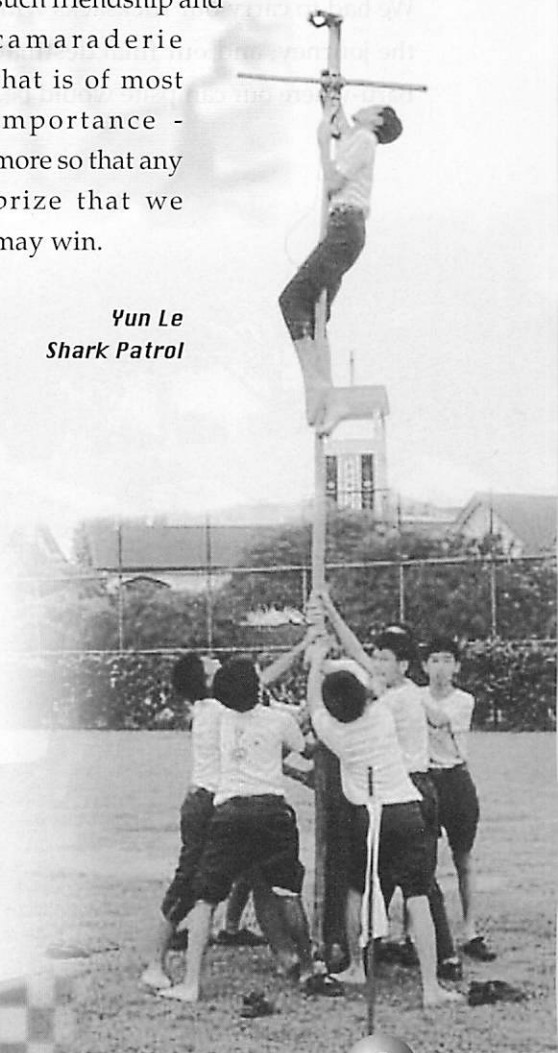

Jurnal Campfire

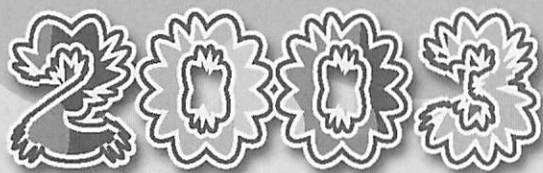

(Kebun Baru)

As usual, all scouts met up before the camp in school. Everyone was excited, while others a little frightened after hearing the different stories told by our seniors about camps. We checked through our rucksacks one last time before inspection, hoping we hadn't missed out anything.

Soon, the camp had started. Following inspection was the first activity of the day- a hike. We had to carry our rucksacks with us throughout the journey, and our final destination was Kebun Baru-where our campsite would be. Along the hike,

there were many checkpoints, and 2 'pit-stops', where there were bonus points for us to get if a task was completed. After all, we were all enthusiastic about it as it concerned the "Best Patrol" award for this camp. However, the hike was still rather tedious, despite all our enthusiasm.

Finally, at nightfall, everyone had arrived. We then had our dinner, following which we proceeded with the camp development- building of gadgets, gateway, and pitching the tents we were going to sleep in.

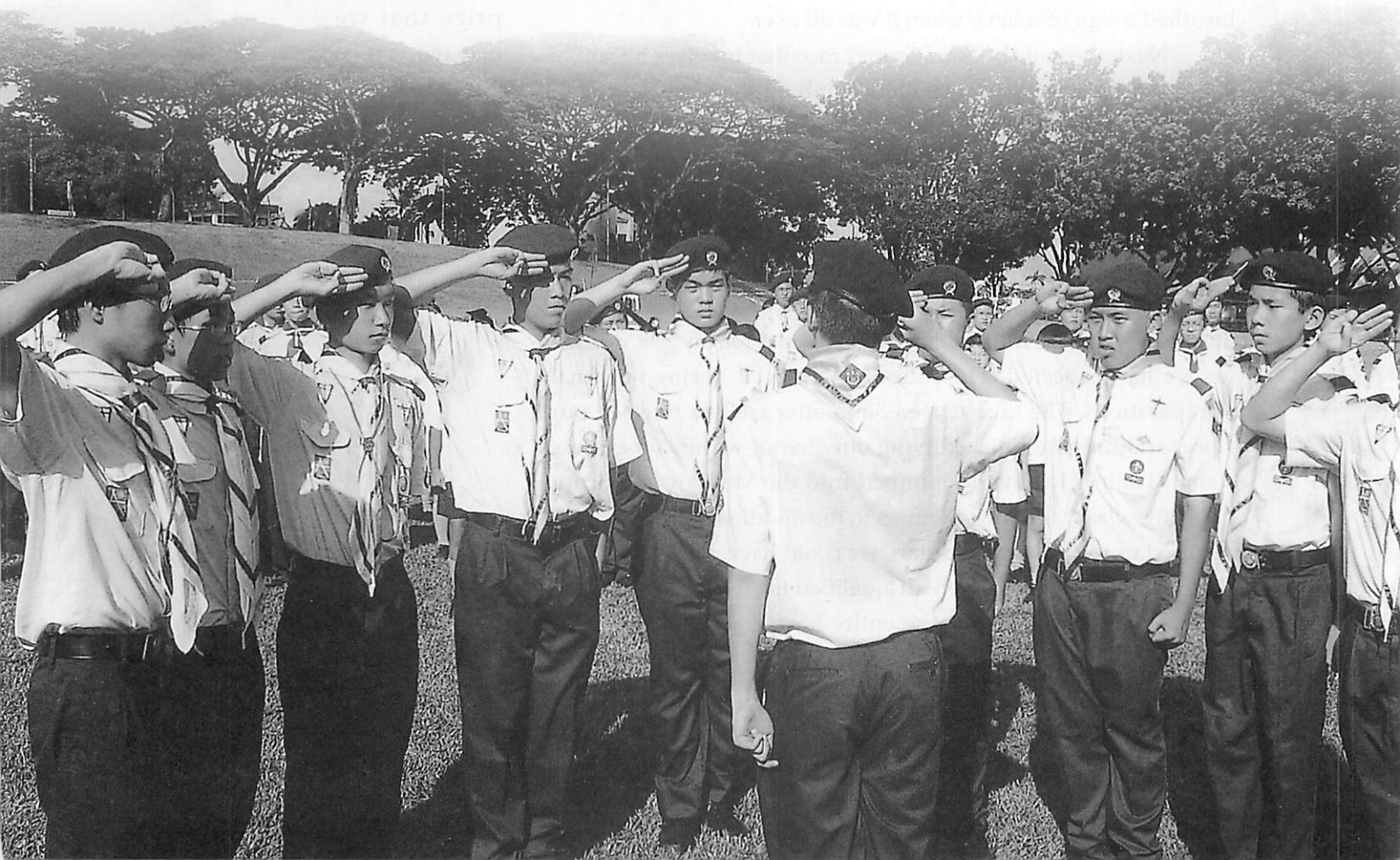



Next morning, the activities were similar to previous camps that I have attended: PT (physical training), followed by inspection/breakfast. After these few activities, we had a photo-taking session so as to have something to remember about for this camp. The day's activity was mainly VOJ (venture obstacle journey), as it always occurred in previous camps. But this particular one was a totally different experience. We had to hike to the nearby pierce reservoir, at which VOJ was conducted in the 'natural' environment. It was unique as the different stations' activity was a first-time experience for us, especially the sec 1s.

This VOJ session included many stations, thus all couldn't be completed in a short period of time. Thus, there was a break in between and we had our lunch. After which, the activities then resumed, lasting all the way till dinnertime. Turns out that we spent the entire day at pierce reservoir, a truly new and intriguing twist to the camp. At around 7pm, the next event began. We entered a game of 'shadowing', a camp favorite, played in unknown and vast surroundings. The clues all led us to Bishan Park, where we had our supper. The sec 1s and 2s were then split from the sec 3s, who were heading for

their solo night. The rest headed back to camp and continued on for the 2nd part of 'shadowing', which was now modified into some sort of a treasure hunt. While it was certainly very fun, we eventually got tired, and were glad when the order was given for a lights out.

The 3rd day of camp saw most of the scouts considerably exhausted and sleepy due to the on-going activities over the past 48 hours. However, many were looking forward to today, when the cadet scouts would join us for some fun activities. Following our morning routine, the cadet scouts merged into the scout patrols and joined us in the many games arranged by the ventures. Not only did the cadets enjoy them, most of us did too!

Lunch arrived shortly, and after the meal, we were led into a lesson of survival killing-conducted by Wei Xin. The poor victims of today's kill were a python, frogs and fishes. Only after the killing did we realize that these animals were to be part of our dinner, which would be accompanied by the food prepared by us during the backwoods cooking taking place not long after. As this was our last night at camp, we celebrated our joys during the campfire that night. We enjoyed ourselves, singing songs, and viewing entertaining skits performed by our fellow scouts.

We demolished our campsite late that night, preparing ourselves for the activity coming up next. Another hike it was! This time, it was even more daunting one which

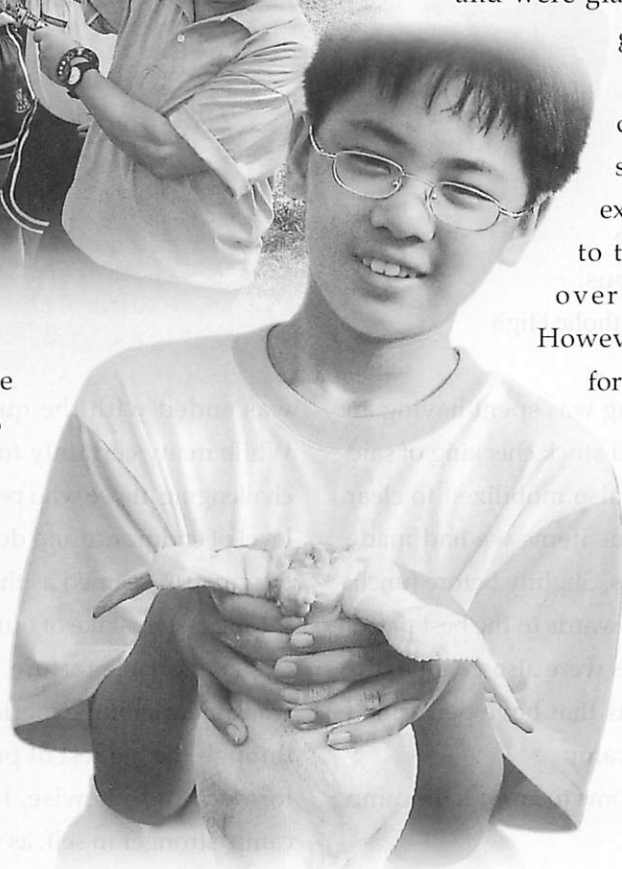

would lead us to the Esplanade. Off we went, and upon reaching our destination, it was nearly 4am in the morning. We had a short nap there, before boarding a bus, which brought us back to Catholic High Secondary at Bishan.

The very last morning was spent having an inspection of equipment and stock checking of said equipment. Everyone was also mobilized to clear up and wash up the various items we had made use of during the past 4 days. Slightly before lunch, we had the presentation of awards to the best patrol (Mole Patrol- Tiger). Awards were also given to the sec 1, sec 2, and sec 3 scouts that have performed well over the course of the camp..

Finally, as all things come to an end, the camp



was ended with the quintessential "Bersurai!". While many certainly found the camp tough and challenging, those who persevered attained a greater level of endurance and determination. While during the camp, it seemed as though each of us had made the biggest mistake of our lives subjecting ourselves to such horrible torture, in hindsight, I feel that it was an enriching experience. For only by passing through the highest of pressure, can a diamond be formed, and likewise, I have emerged from this camp, stronger in self, as well as in the ties that bind me to my close friends.

Marcus Leong
Tiger Patrol



National Orienteering Competition

This year's orienteering competition was held at Ang Mo Kio West Park on the 19th of July 2003. Our team consisted of six members – Benjamin Hong (team leader), Aloysius Ho, Chan Qing Huang, Ryan Liew, Shawn Lau, Jia Jing and a reserve – Bryan Koh. Many other schools also took part in this competition. Each team was given a map of the park. The main objective was to locate all 22 checkpoints as quickly as possible. The location of the checkpoints were hidden in a riddle or a clue, which we had to solve.

The day started badly due to some miscommunication. The team was "separated" and by the time we were finally reunited at the park to register, it was already 10:45 a.m. (we were 15 minutes late!) We still managed to register but we started off 5 mins later than other schools. Luckily, we were fast and caught up due to our team's good coordination and teamwork.

By the fifth checkpoint, we had drunk almost all our water and had to go on rations. Soon we realized that we had only 3 hours to complete 16

checkpoints! Thus we jogged our way around instead of walking. Unfortunately, we had one drawback; the whole team had to stay together and we were slowed down by the slower team mates.

The organizers of the competition were cunning and tricky. We had to crack our heads to solve their riddles or clues and the next checkpoint would normally be very far from the previous one. Often we had to climb many stairs just to get there. Once we even had to use strong long sticks to help us walk.

In the end, we managed to find only 17 checkpoints and came in second, behind Pei Chun Public School, which found 20. Overall, we found the competition a tiring but wonderful experience for all of us.

Aloysius Ho and Chan Qing Huang
Cadet Scouts

After note:
Incidentally the scout section came in 3rd
and the venture section clinched the 2nd
place.

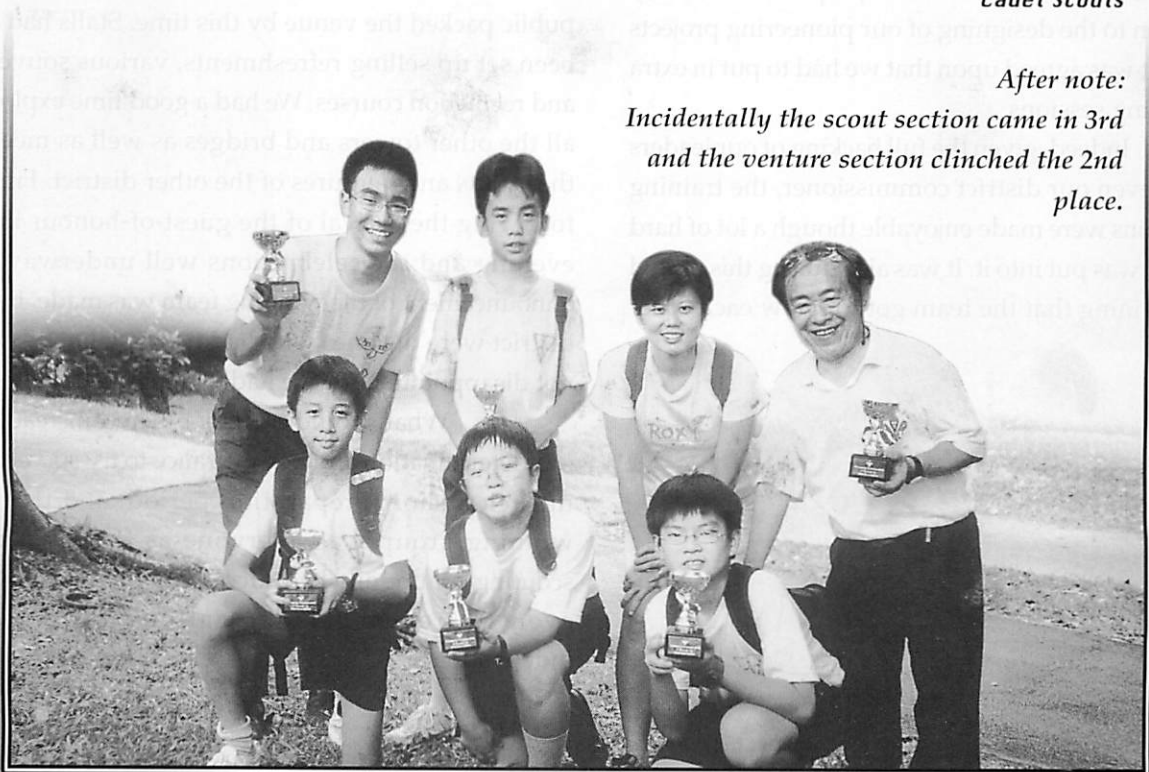

NATIONAL INTER-DISTRICT PIONEERING COMP

The invitation was put down to us and we were ready for it. As part of our nation's 38 years of independence celebrations, The Singapore Scout Association organized a carnival of sorts, which involved all the scouting districts in Singapore. The challenge was to show showcase the best of our scouts' pioneering skills, to work as a district and put up the best design for towers and bridges. It was a rare chance and indeed a unique idea to finally group the various schools together in the spirit of scouting.

Without a shadow of doubt, Catholic High Scout Troop was proud to have participated in an event which honours our nation, thus by collaboration of our scout leaders of Ang Mo Kio district, we met up with the Shadow scout troop. Comprising of scouts and ventures from the Mayflower, Braddell-Westlake, Pierce and Catholic High, two groups were quickly organised to form the tower and bridge team. Given that we had less than two weeks to prepare, we swiftly got on to the designing of our pioneering projects and it was agreed upon that we had to put in extra training sessions.

Indeed, given the full backing of our leaders and even our district commissioner, the training sessions were made enjoyable though a lot of hard work was put into it. It was also during this period of training that the team got to know each other

better and through which shared our different experiences of scouting. Even though it was only a short two weeks of training, what has been gained by us ventures and scouts is nothing short of invaluable.

Come 8 August 2003, we were well prepared for the competition. The event was taking place at the Marina promenade and was also opened to the public to join the experience. At approximately 9am we reached our venue and unloaded our equipment, brimming with excitement. Though it seems some had already started the night before, we were confident that we were able to complete the Bridge and Tower in the allocated time. When the go ahead was given, we steadily set to work under the unrelenting heat. All our scouts were sure of what they had been assigned to do, thus our structures took shape very quickly. When the whistle was blown to signal the end of the competition, all our decorations had already been put up, waiting to be viewed by the impartial judges.

Scouts, guides, parents and everyone else of the public packed the venue by this time. Stalls had also been set up selling refreshments, various souvenirs and recreation courses. We had a good time exploring all the other towers and bridges as well as meeting the scouts and ventures of the other district. Finally, following the arrival of the guest-of-honour in the evening and the celebrations well underway, the announcement of the winning team was made. Bedok district were the ones who had triumph but we were not disappointed, for we had a great time together.

What should be remembered instead was our determination and perseverance to try succeeding in such a short preparation period, and that the winning group was everyone as the Singapore scouting community had successfully put together an event to remember our nation's struggle to independence.

Kenneth Zha
Venture Scout



Girl Venture

Investiture

It was a significant day for us. Denise and I would be invested and will officially be part of the CHS scouting family. On that day, we were both excited and nervous. We had no idea what we needed to do during the ceremony. After much anxiety and anticipation the much-anticipated moment had arrived. After placing our hands on the flag and reciting the Scout's Promise, Mr. Chua helped us put on the scarf and lanyard. We could now call ourselves Girl Ventures.

I started to think back on what we've done for the past few months in scouts. The very first meeting was the Girl Venture Orientation at Sentosa. It was more like a get-to-know each other session. We had a great time there. In the subsequent meetings, we spent time organizing activities for the scouts and also carrying out trainings for them. Through this period of time, we fostered stronger bonds among ourselves. We shared the joy and pain we had since we received no special treatment despite being girls. We did what the male ventures did, picking up many skills along the way.

My first camp in scouts was the National Venture Leadership Camp. It was a mentally stressful camp. Even

before the camp, the preparation work gave me a big headache. However, I gained a lot through this camp. I've learnt how to work better with my fellow ventures, how to organize activities and also character building. Despite having to conduct the Sixers Training Camp, we too had to go through our own training at the same time. I've made many new friends during the camp. As the scouts law states, "a Scout is a friend to all and a brother to every other Scout."

Besides the camp, Denise and I had also taken part in the annual inter-district competition. It was a wonderful experience for both of us. We had brushed up on our pioneering skills. The grueling training did not dampen our spirit and enthusiasm. Although both the bridge and tower teams did not win any prizes, we are happy that we managed to complete the whole project. The completed structure gave us a sense of achievement and satisfaction.

Being a girl venture is a start of a new chapter in our lives. We seek to learn more useful skills and apply them to the challenges ahead of us. Hopefully, we can achieve more next year and take a few steps towards the PSA.

Chiang Yuen Ching
Venture Scout





Memoirs of PSA

and DCA holders

Reflection on the President's Scout Award

It was only upon receiving the President's Scout Award (PSA) from the President of Singapore, Mr. S R Nathan, did I realize the great prestige and honor of the award. It is an end to your years of venturing and a whole new life long bond between the recipients and the world of scouting. The award itself is the highest achievement one could attain in his venturing years. It puts one through a series of tests to determine his capability for the award.

Doubts clouded my mind when I first started out to work for the award. As I was still unsure of whether I was able to make it through the challenges set forth in the new syllabus. With the right set of mind to be prepared for everything, I was able to overcome this problem. Although it took a lot of time but it was all worth it.

Many said that pursuing a goal is indeed time consuming. I totally agree as sacrifices got to be made for success to come. Much of my leisure time and social circles throughout this period were cut down. This is where my time-management skill comes in. Time consuming it may be, but at the end

the fruits of your labor will be sweet.

The award itself allows one to attain it at ones own pace. It is only through a person's determination and motivation that one can bear its fruits. This is because there is always a point in time you may feel exhausted and may have the urge to give up the award. I am also no exception of such feelings. However, we are all humans after all, it is only with the right motivation that one will brave through such times. Only those that are able to come up of this difficulty will be fit to receive the award.

The tests and courses were sometimes grueling and edgy. This is because tests and courses similar to the venture cord hike and the A.S.P.I.R.E. will always keep you on your toes. You will never know what will happen next. In addition, it drains you not only mentally but physically as well. With the new section on HQ project, it allows you to put your leadership and management skills to use. From here there seems more that just only mental and physical skills of a candidate are tested but also his personal relation skills are also put at a test as well.

After all a PSA holder must possess certain moral values as well.

Other than meeting with challenges along the way, friendships were also forged along the way. These friendships forged not only in adversities but had also developed into long lasting friendships through my life. They not only keep one up to date on new scouting skills but also what scouting meant to different people.

Giving my final salute as I stepped off the stage, nostalgic thoughts of the journey to this day flew past my head once again. It was lovely. Discovering that the award was more than just a few snap shots or a scroll of recognition, but a life long journey of learning and bonding. Here, I would urge all those that are already on their way or had already decided to do it, not to take it up lightly. Give it all your best and you will be awarded rightfully.

Last but not least, I would like to thank those that had helped me in one way or another to attain this award.

Willy See
PSA Holder



The DCA and Us

When my friend Benjamin and I joined scouts, we were determined to be the best. Finally, after 4 years, that goal has been realized.

The district commissioner, Catherine Heng, came on the 8 of November 2003 to interview us. We had to wait a bit as she first talked to our Group Scout Leader Mr. Chua. During that time we were both nervous and excited. During the interview it self, the district commissioner asked us questions like "what made you determined to get this award." To which we told her about how we had always wanted to be the best. After the interview, the district commissioner told us that we made it for the DCA.

Now that I've gotten the award, I hope to continue scouting in secondary school and maybe attain the CCA.

Nicholas Tham
Red Six



Catholic High School Scout Group
Dist Comm Award Holders 2003

BENJAMIN HONG

NICHOLAS THAM



Small Kindness Camporee-

President's Challenge



Singapore Scouts

Chief Scout
MR S. R. NATHAN
President of the Republic of Singapore
President
MR NOEL HOV C. C.
Chief Commissioner
MR NICHOLAS TANG HING

16 September 2003
Dear Leon M.Ryan,

PRESIDENT'S CHALLENGE - "small kindness camporee"

The Organising Committee of the above event takes this opportunity to thank you for your support in the above mentioned event on 6th - 7th September 2003 held at the Sarimbun Scout Camp. Your active participation has contributed to the success of the event.

We have an overwhelming response from our Scouts who were great buddies in looking after the youths from the VWOs. We have achieved our objective to lend a hand to the less fortunate youths who are non Scouts in our community.

Thank you.

Yours sincerely,

Mr Anthony Tang PBM
1st Deputy Chief Commissioner
& International Commissioner

#2

as part of its participation in the President's Challenge organized the "Lend A Hand" charity camp. Leon, Chee How, Gordon and I were representing Catholic High at the camp.

singing all the usual songs and there were also two items put up by the West and East Areas. To sum it all up, the campfire was most entertaining, which made up for its short duration. Well, some Scouts took it into their hands to start a chaotic bombing session when the campfire ended, which resulted in strings of incoherent dialect that mostly originated from the Pierce scouts. It was rather encouraging to see bursts of Malay and sporadic pockets of Indian cheering; signifying a real integration of everyone is the scouting spirit.

Basically, our job was to carry out a game involving the five senses, aka Kim's game, for the camp participants. The campers included both scouts as well as boys from different welfare organizations that are under the umbrella of government aid. The camp was a short-lived one, lasting only 2 days and 1 night.

The boys started their activity in the late morning on the first day. Leon played some tracks from a CD and the boys were supposed to guess what the sounds were. It was amusing to see them mistake heartbeats for a train or be baffled by the cries of a peacock. Following that, Chee How and Gordon passed objects around for them to smell and touch. Some of those items were soya sauce, garlic, a small rock etc. We also tested the boys on their eyesight and memory with the use of about 20 different objects and the help of two Chinese High scouts. Lastly, we gave them different samples of food to taste, such as sugar, milo powder and biscuit crumbs.



The major event in the evening was the campfire, which was hosted by a very animated MC. Did I mention that the campers were divided into the West side and the East side? Anyway, the MC led us in

While the camp was short, it certainly provided for an entertaining and enriching experience. Certainly there were its dull periods, but the jubilation of the campfire and the merriment of the scouts made the two days spent there seem all too short.

*Hoo Kuan Liang
Venture Scout*

Master-at-Arms Proficiency Badge



The master at arms badge is a proficiency badge. It is a badge that allows you to show off your skills in fighting, literally. As the name implies, to earn this badge, there are a few pre-requisites. You will need to be familiar the types of weapons used in combat, how is it used, how it is used under safely guidelines and how to ensure the tool is in proper conditions. A few common weapons you can find in your daily life are knives, rods, axes and spears.

Although this badge is commonly associated with fighting and blood shed, but this is actually not the case. This badge tests your ability to differentiate weapons, and the markings they leave after usage. For example, the cut on a block of wood using a parang and axes are different. Candidates are required to be able to differentiate the wounds caused by some simple weapons.

Also, candidates are required to be able to defend themselves from aggressors without using weapons (unarmed combat). These basic techniques could be easily learnt from martial arts textbooks, preferably one with picture illustrations. A few schools of martial arts accepted are Judo, Tae Won Do, Karate, Ninja etc.

It is important to note that all the forms of martial arts recommended are not meant aggression, but for strictly self-defense only.

I got my master at arms through teak won do. I am currently a black belt recognized by the world Tae Won do federation. During my scouting

years, I was only a red belt. In order to get this badge, one must be red belt and above for the case of tae won do.

Identification on the certificate is very important, it is the only valid proof of one's skills.

In tae won do, I was taught the various techniques of self-defense, how to unarm a opponent, fall an opponent, evade from

opponents etc. Focus was placed on the basic kicking and punching

techniques. It is indeed not easy to throw a punch to knock out an opponent

bigger than you are, but if the techniques are right, you will be able to control your

force, and might be able to knock him off. Fatal points of the human

physique are also taught. Regions like the sternum, the throat and the groin are

exceptionally vulnerable, and one would be wise to guard these regions from attacks. Stability is also taught.

Concepts related to lowering the CG of human bodies are taught to allow me to remain standing after a strong push. Finally, and most importantly, the dos and don'ts in real life situations are explained. Tae won do is a skill, thus no one can perfect it, it has to come with constant training, or one will turn rusty. Skill itself is also not enough to deter attacks, fitness is also very important.

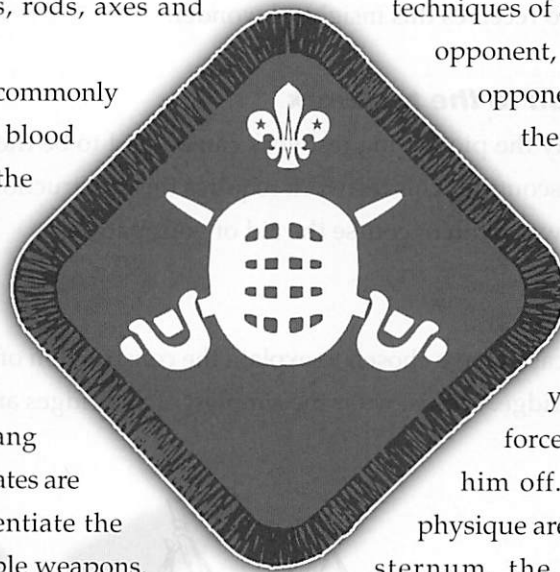

Chen Li Qian
Venture Scout

PIONEERING 'KNOW-HOW'

Introduction

Pioneering is to many people a useless skill. To the simplest of Man, the building of structures with wood is now totally unreliable and impractical. But to us, scouts, this skill is a must have and can be easily likened to a form of art. Few people can actually realize the immense potential of creating a "building" out of poles, and even fewer actually believe in the stability of the structure. In truth, the structure built by any one scout is strong, firm and majestic. It dwarfs the average human and leaves them wide-mouthed in surprise as they gape at the astonishing height to which the tower can climb to, or they marvel at how large and sturdy a bridge can be built to. Pioneering is in short a must-have ability of any scout, it is a sense of identity in which we can take pride in as we consider the respect we gain from the public who receives this insightful wonder.

Introduction to the testwork

Basically the pioneering testwork can be said to be the most interesting testwork in your years of scouting. This testwork requires the construction of either an aerial runway, a bridge or a tower. With of course the aid of your patrol.

The Test

In this case I have chosen to explain the construction of a very simple project namely the monkey bridge. This is by far the simplest of all bridges and requires very little effort to bring up.

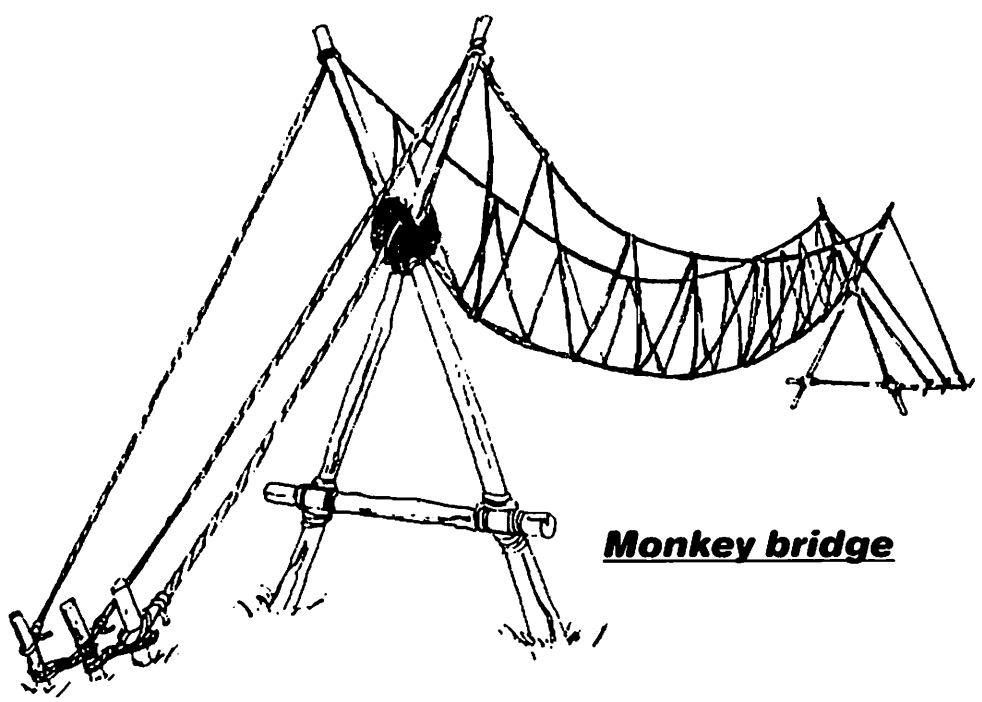

Monkey bridge

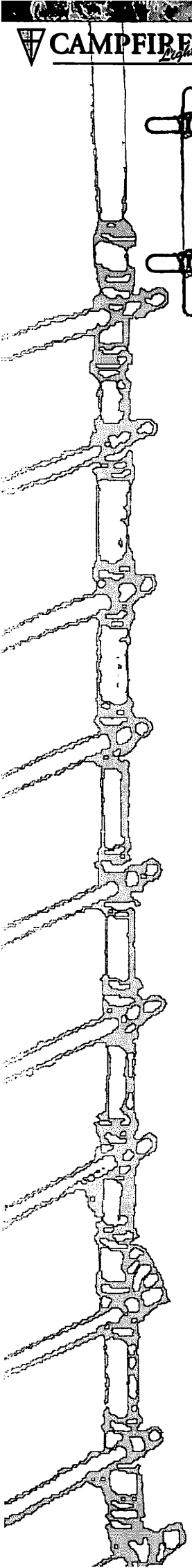

Steps to take

1. Construct an "A" Frame using three pieces of wood.

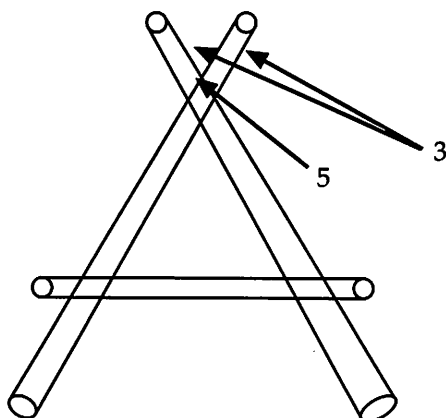

2. Superimpose the second "A" Frame on top of the first one.
3. Tie guylines to each of the protruding end at the top of the "A" these guylines must be tied to the other "A" Frame too. As shown in the picture these lines will serve as railings for the bridge.
4. Next set the two "A" Frames some distance apart in an upright position and knock intings to hold them in place.
5. Now Thread a thick guyline through the intersection of both the "A" Frames, tie this guyline to the intersection of the "A" Frames
6. Secure all guylines to the ground by knocking intings into the ground and tying the guylines to it.
7. Use nylon to create a safety net by zig-zaging the nylon through the railings and the main guyline.

Other aspects of pioneering

1. Decorations: deco can be used to liven up any structure built. It creates a "feel-good" effect on all who view the structure. Simple deco can be the use of flags and different coloured ropes/ wood while more difficult deco involves large banners.
 - Large banners: Banners are a very good way to create an imposing feel to your structure. These banners require a lot of work to finish basically it involves pasting of stickers on large pieces of cloth, the stickers can be pictures of majesty or the names of the school or organization by which the structure was constructed.

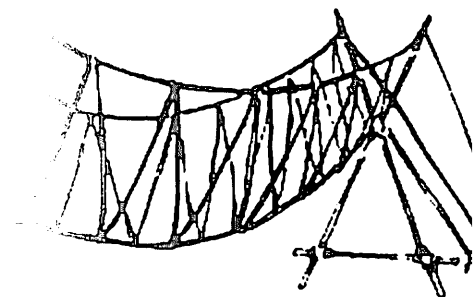

- Flags: Flags are the best way to catch one's eye. The flag has always been a symbol for respect and it will definitely spice up the structure in terms of its beauty.
2. Knots: The knowledge of knots are a must for all who proclaim themselves as scouts pioneering is the only other testwork which focuses so much on knots other than the knots testwork. Basically there are knots for every purpose be it to secure two pieces of wood together or to join many pieces of wood together to create a platform.
 - Square Lash: This is the most basic of all pioneering knots, it is used to secure two pieces of wood together in an "X" fashion.
 - Diagonal lash: Similar to the square lash it is also used to hold two pieces of wood in the same way but is much more flexible than the square lash
 - Sheer lash: Used to join wood vertically together this way a piece of wood can be lengthened through this method.
 - Figure of Eight a.k.a Tripod knot: As the name suggests used to tie tripods it is also the most flexible of all knots it allows the wood to be moved freely even after it is tied.
 - Snake and ladder: A very important knot, it is used to tie many pieces of wood together to create a platform. All pioneering achievers must know this knot very well.



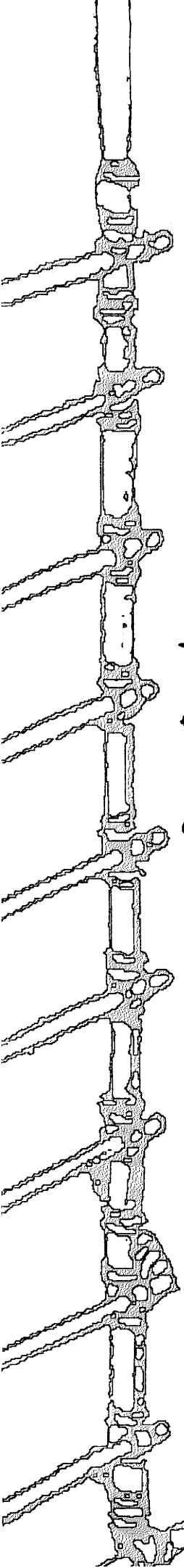

PICTURES OF OTHER PROJECTS

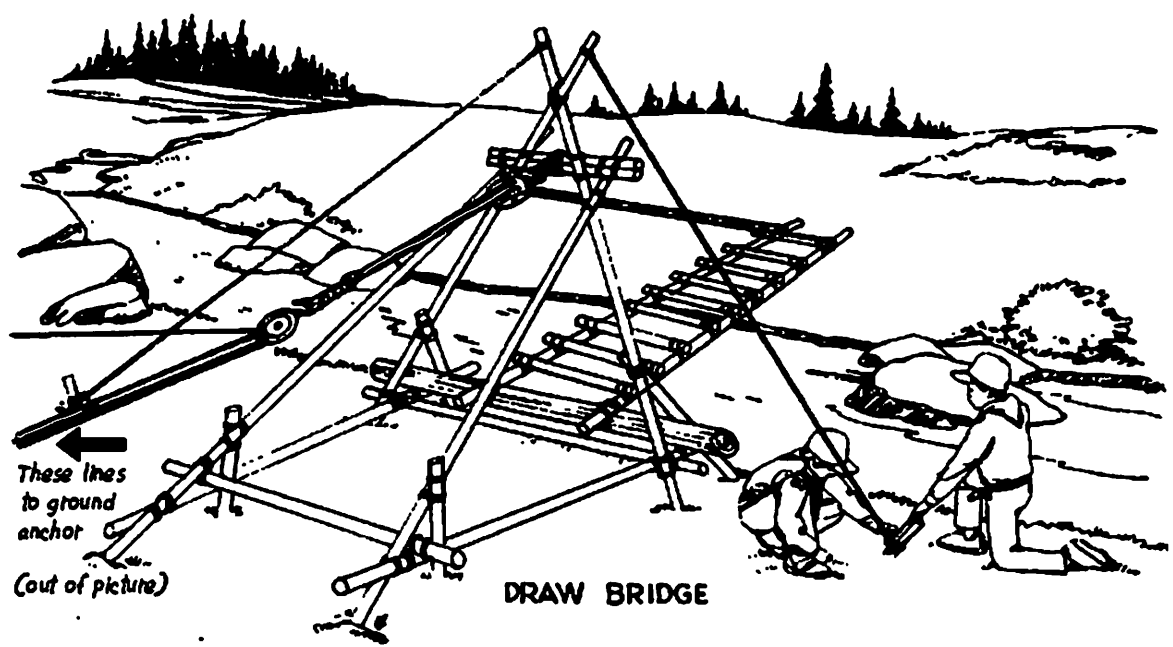

These lines
to ground
anchor
(out of picture)

DRAW BRIDGE

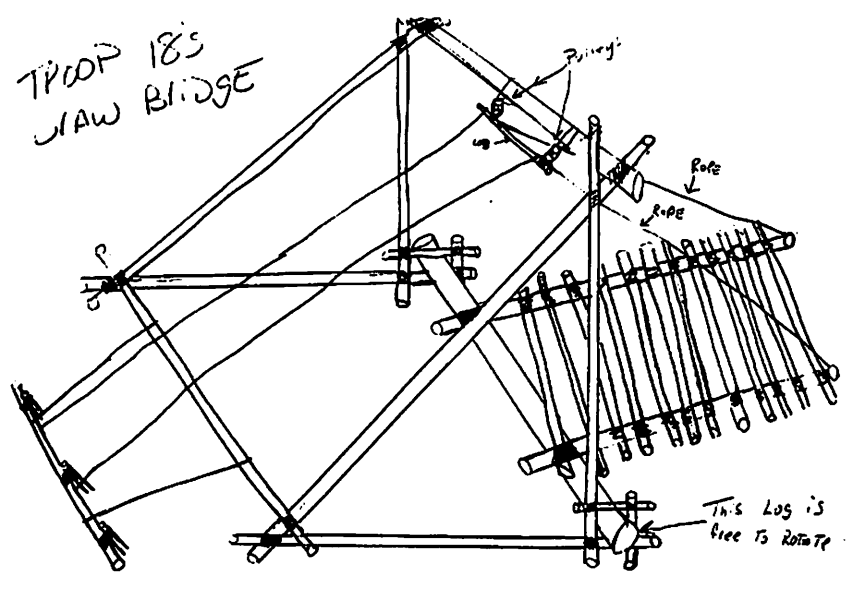

TRPOOP 18'S
JAW BRIDGE

This Log is
free to rotate

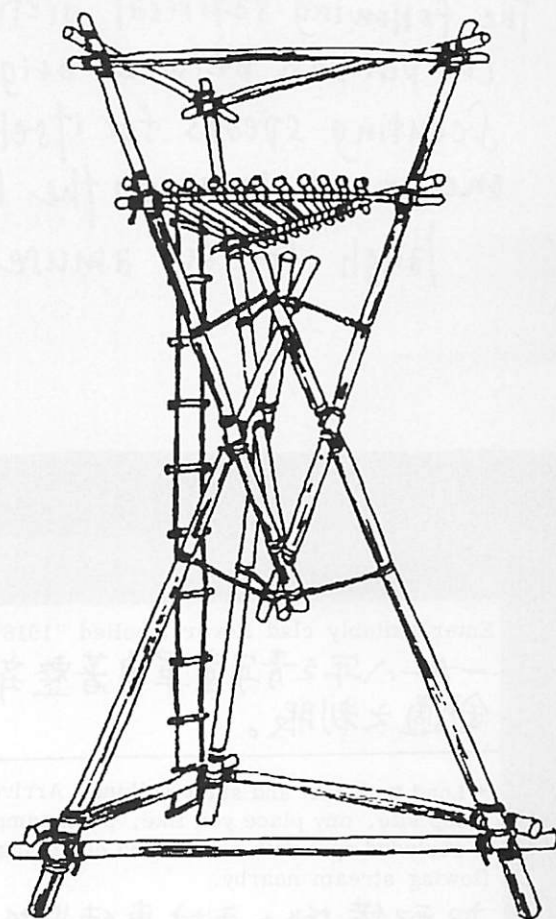
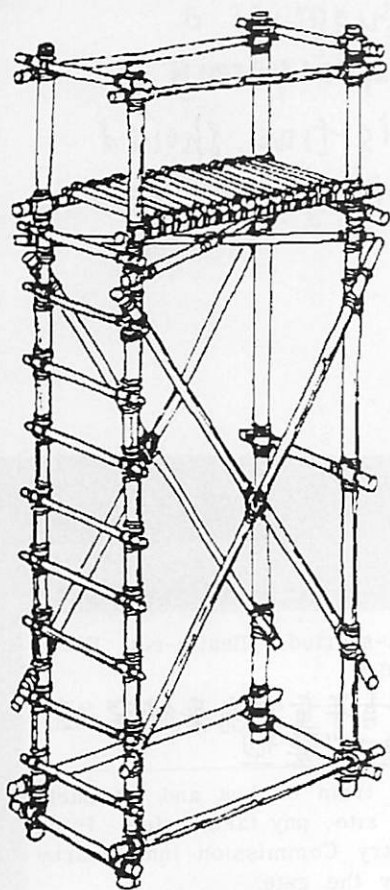

Brynbach Tower

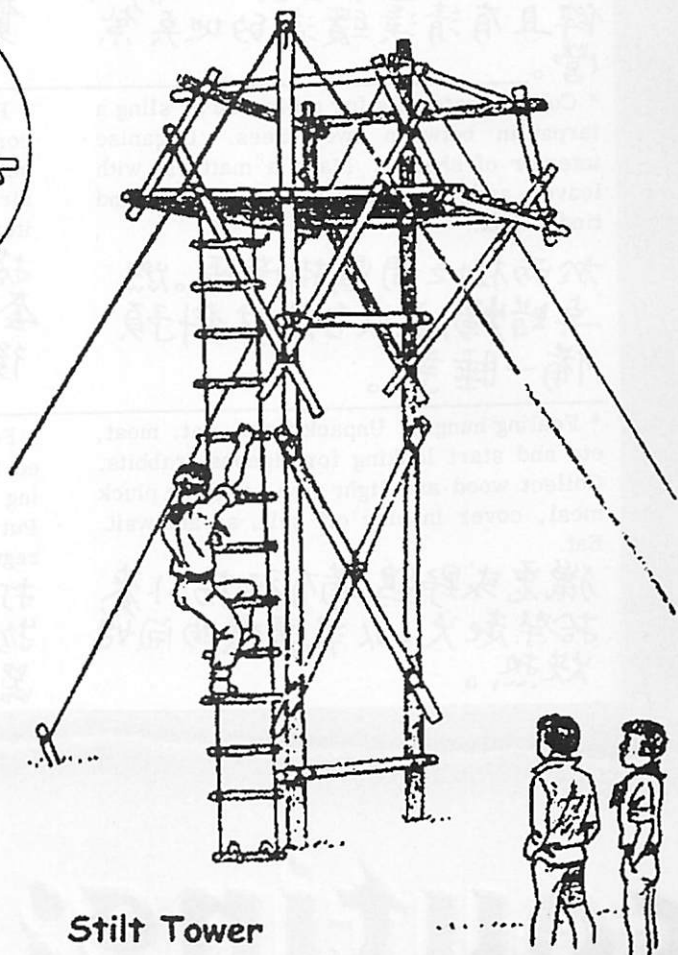
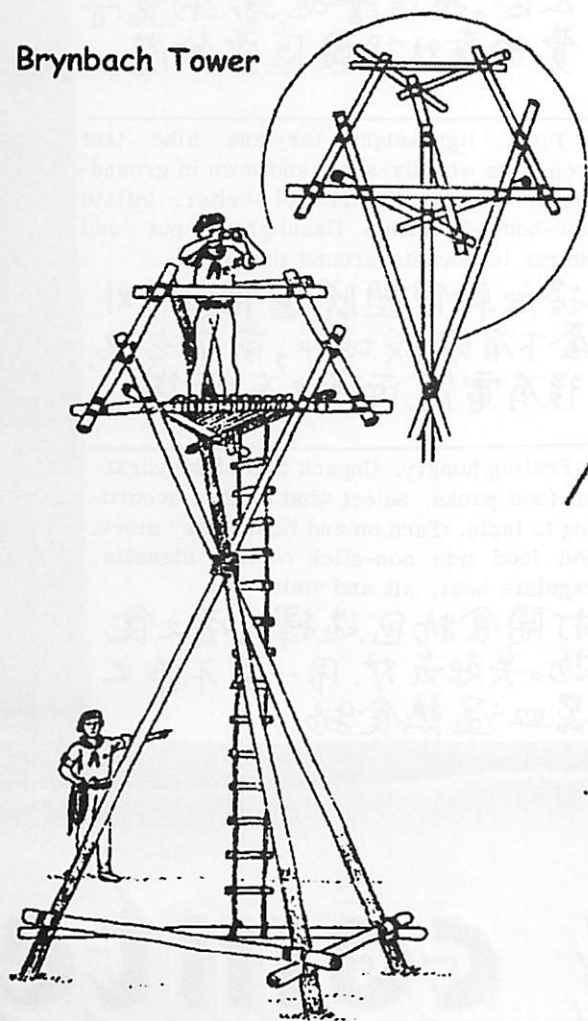

Stilt Tower

The following satirical picture which suggests a comparison between original and contemporary Scouting speaks for itself. But it is true, should one read between the lines, or is it just a laugh for our amusement?

Enter suitably clad Rover labelled "1918"
一九一八年之青年童軍身著整齊
舒適之制服。

* Load trek cart and start walking. Arrive camp site, any place you like, pitch camp. A secluded spot with a wood and clean, fast flowing stream nearby.

把配備搬上手拉車徒步抵達營地。選擇喜愛之幽靜偏僻且有清溪緩流的地點紮營。

* Collect materials for a bivouac or sling a tarpaulin between two trees. Organise interior of shelter. Make a mattress with leaves and branches, position candle and tinder box.

於兩樹之間懸掛營帳。燃真蠟燭，並以自然材料預備一睡墊。

* Feeling hungry. Unpack flour, oat, meat, etc and start looking for pigeons, rabbits. Collect wood and light fire. Skin or pluck meal, cover in clay off self, sit and wait. Eat.

獵兔或野鴿，備有麵粉、小麥，拾柴起火。以泥裹獵物開始烘熱。

Enter short-shorted, Beatle-cut Rover labelled "1964"

一九六四年青年童軍身著狹窄短褲"披頭四"髮型

* Load car, train or bus and sit back. Arrive camp site, pay farmer fee. Pitch camp; Forestry Commission land nearby and a tap by the gate.

把配備裝入汽車、巴士或火車出發。抵達營地，繳納露營費，於森林保護區旁紮營。

* Pitch lightweight terylene hike tent complete with fly-sheet and sewn in ground-sheet. Organise interior of shelter. Inflate air-beds, position flashlights, put odd items in pockets around the walls.

搭起輕便塑膠營帳，上有外套，下有現成地布，前有汽枕，後有雷筒，兩旁又有帳袋。

* Feeling hungry. Unpack tins of dehydrated food packs. Select what to have according to taste. Turn on and light "Gas" stove. Put food into non-stick cooking utensils, regulate heat, sit and wait. Eat.

打開食物包，選擇喜愛之食物。真起氣爐，用一塵不染之器皿溫熱食物。

* Wash up using grass, ashes and water, the latter having been carried from stream in Scout hat.

以童軍帽盛溪水，
利用茅草及炉灰洗滌器皿。

* Wash up using rubber gloves, mop, squeezy and water, the latter having been carried from tap in polythene water container.

以膠袋盛自來水，裝
上膠手套並用潔粉洗滌。

* After resting, a short hike, dressed in calf-length shorts, clogs and hessian coat, finding ones way by the sun and world atlas open at Great Britain page.

休息後，武裝出發，短途遠
足，沿路以太陽尋找方向

* After resting, a short hike, dressed in anorak, lightweight boots and breeches, using prismatic compass, signposts, main roads and 2½" per mile O. S. map.

休息後，也武裝出發，短途遠
足，沿路用地圖，指南針，路牌。

* Back to camp. Raining hard, thoroughly soaked, collect more branches for bivouac. Find dry wood to light fire for evening meal.

歸營地，下起大雨，滿身有如落
湯雞。收集乾材起火取暖煮飯

* Back to camp. Raining hard, fasten pac-a-mac, go round slackening off guy lines. Light stove in canopy of tent and prepare meal.

歸營地，下起大雨，著雨衣，解
鬆營繩，燃臭氣爐煮飯

* Settle down for evening, light candle, make bed with blankets, newspaper and pins, put on more sweaters and lie back.

燃燭預備入寢，著寒衣並以
報紙作被。

* Settle down for evening, light flashlights, switch on transistor, unroll terylene sleeping bag and slide on.

啓開電筒，收音機，穿入睡袋
以備入眠。

* Listen to the wind and birds, the stream flowing by, the rain dripping into blankets. Try to sleep. Middle of night. feeling cold and thirsty, sucks pebble.

耳聞風嘯鳥鳴，溪水流
聲，雨水滴音。夜半飢渴
寒宿。

* Listen to the planes, the cars on the main road nearby. Off to sleep. Middle of night wake up rather warm, feeling thirsty, has drink out of plastic water bottle.

耳聞上空機聲，路旁車聲。
夜半暖渴，自水壺倒水
止渴。

pory or original?

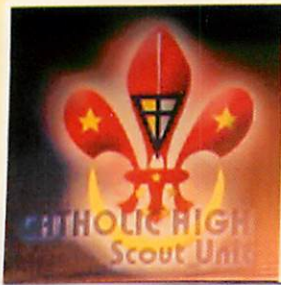

Catholic High Scout Group 55th Anniversary Dinner

